

**CONCRETE
SLEEPERS
N.S.W**

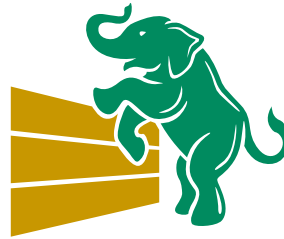

**CONCRETE
SLEEPERS
N.S.W**

Concrete Sleepers N.S.W



Proven Product

We use Outback Sleepers which have been making concrete sleepers for over 20 years and have manufactured over 3 million of them. It's no wonder why they are so good at what they do.

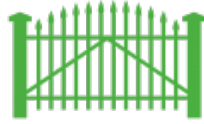

A Product For Every Project

It does not matter what style of retaining wall you need. We promise to have a style that will suit your landscape project and help bring beauty and value to your home.



Superior Strength Concrete

The stronger the concrete, the more durable your retaining wall. With decades of experience in the building industry we know that our products are the strongest.



Exceptional Sales Service

When it comes to helping you with your landscaping project, we know our products inside and out. So for friendly advice and fast order turn around – call us today.

Your Local Specialists for Concrete Sleepers.

Strength and durability are our absolute priority.

The construction of one or more retaining walls will be an essential part of a new home or garden landscape. It is often one of the first projects undertaken and one of the costliest and hardest to fix if not done correctly the first time. For this reason, your retaining wall must last as long as possible.

Concrete Sleepers are the perfect retaining wall building material. The strength of concrete allows you to build higher walls, and they will never rot or be affected by pests. These characteristics make them the ideal zero maintenance solution.

Concrete retaining walls are easy to install and perfect for levelling sloped land, minimising erosion, creating feature garden walls or simply building several veggie patches.

**Add Value,
Space and
Style to
your Garden.**



Strongest in the market.



Our Sleepers•

What Makes Our Concrete Sleepers Better Than The Rest?

We believe in the quality manufacturing at every stage. Outback Sleepers Australia (OSA) recognised from the beginning the importance of continually improving to ensure their products match the requirements of home builders and landscapers (in Australia).

Modern manufacturing techniques allow them to provide customers with sleepers that use industry-leading 60MPa concrete. They easily surpass the Australian standard and the strength of our competitors products, making them the strongest retaining wall concrete sleepers on the market.

Outback Sleepers Australia (OSA) use the latest manufacturing technology and continuously improve their methods, allowing us to provide customers with sleepers of the highest quality.

Our sleepers are certified by a Structural Engineer to have a 50-year lifespan, ensuring that they will be the only ones you'll ever need.

So when it comes to building a retaining wall don't take chances on the quality of your concrete sleepers – it could end up being a very costly mistake. Talk to one of our helpful sales staff and let us add distinction to your landscape design.



Reinforcing Bars

All our sleepers have 2xN10 Reinforcement bars throughout the sleepers.
*Cribs have 1 x N10 Reinforcement bar

50 Year Product Lifespan

We manufacture our sleepers to the Australian standard AS3600/2018, which means that our sleepers are designed for a 50-year product lifespan.

Exceptional Strength

Industry leading concrete strength of 60MPa.
*50% stronger than 40MPa concrete (based on equivalent dimensions).

2m Products:

Standard STD
2m x 200mm x 80mm

Heavy Duty HD
2m x 200mm x 100mm

Extra Heavy Duty EHD
2m x 200mm x 130mm

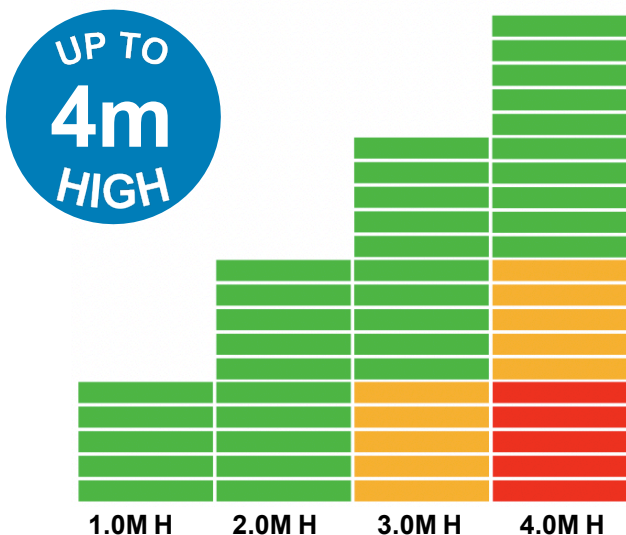



**The only limit is
your imagination.**

Our versatile and attractive products will complement any garden design – from zen garden landscaping to the classic Australian home.



Quality Assured.

There's A Product For Every Project.

Our business was initially established to cater to the growing market for retaining walls, beginning with the idea of adding strength and longevity to Retaining Walls.

The aim was to create a modern and desirable Retaining Wall that would last far longer than timber.

We offer a wide range of colours and designs, giving you complete creative freedom. From the classic 'Lonsdale' to our flagship 'Kensington' sleeper, we will have a style that suits your landscape and will bring beauty and value to your home.

Exceptional Service.

Fast Order Turnaround.

Outback Sleepers proudly manufacture all our sleepers at their Lonsdale factory with the state-of-the-art facility providing consistent high quality products.

They pride themselves on having extensive production capabilities, which enables us to provide a quick turnaround time, which enables us to ensure your landscaping project remains on schedule.

Our friendly staff are only a call away to discuss your design requirements and provide expert advice. We can organise the delivery of concrete sleepers as well as all the retaining wall steel required to finish your project perfectly.

Our Quality Separates us from the Competition.



Our Products.

Concrete Sleepers

1.5m Sleepers.

Standard **STD 1.5m**

- 1500 x 200mm x 80mm
- 2 x N10 Reinforcement Bars
- Build up to 2m high
- Available in Lonsdale and Blackwood only.

2.0m Sleepers.

Standard **STD 2m**

- 2000 x 200mm x 80mm
- 2 x N10 Reinforcement Bars
- Build up to 2m high

Heavy Duty **HD 2m**

- 2000 x 200mm x 100mm
- 2 x N10 Reinforcement Bars
- Build up to 3m high*
- Available by special order

2.35m Sleepers.

Standard **STD 2.35m**

- 2350 x 200mm x 80mm
- 2 x N10 Reinforcement Bars
- Build up to 2m high
- Available in Lonsdale and Blackwood only.

2.4m Sleepers.

Standard **STD 2.4m**

- 2400 x 200mm x 80mm
- 2 x N10 Reinforcement Bars
- Build up to 2m high

Heavy Duty **HD 2.4m**

- 2400 x 200mm x 100mm
- 2 x N10 Reinforcement Bars
- Build up to 2.4m high*
- Available by special order

Extra Heavy Duty **EHD 2.4m**

- 2400 x 200mm x 130mm
- 2 x N10 Reinforcement Bars
- Build up to 2m high*
- Available by special order

Extra Heavy Duty **EHD 2m**

- 2000 x 200mm x 120mm
- 2 x N10 Reinforcement Bars
- Build up to 4m high*
- Available by special order

Cribs.

2m or 2.4m Crib

- 2000 x 100mm x 100mm or 2400 x 100mm x 100mm
- 1 x N10 Reinforcement Bars
- Available by special order



Blackwood.



Lonsdale.





McLaren.



Cove.

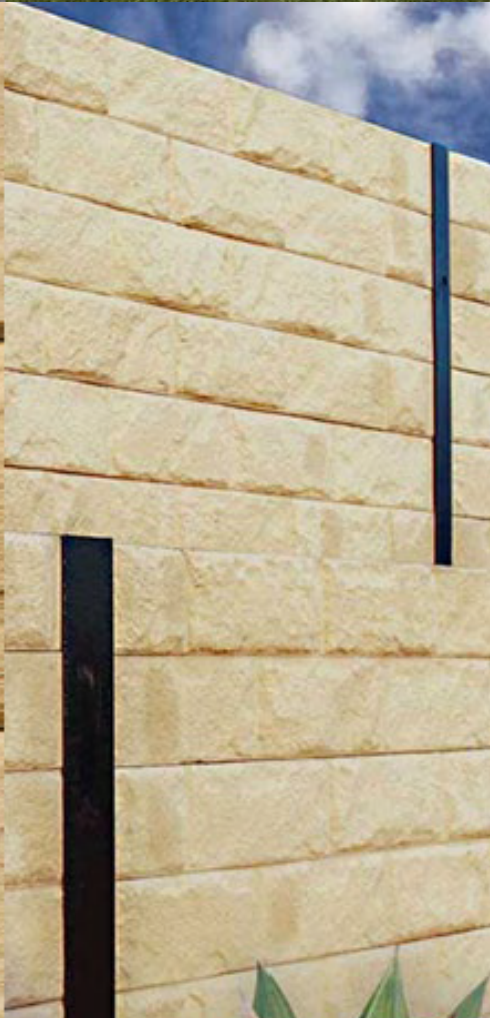



Ashwood.



Kensington.



Our Products.

Under Fence Plinth

Prolong the Life of Your Fence. Gain Privacy. Fill the Gap.

Blackwood.

Lonsdale.

**The only engineered
concrete under fence
plinths on the market!**

If you are installing a fence, then our Under Fence Plinths (UFP's) can improve both the fence's appearance and durability.

Under Fence Plinths prolong the life of your fence by preventing the fence panel from sitting in the dirt and rusting. UFP's also fill the gap underneath boundary fences and provide extra privacy for your property.

Our Under Fence Plinth's are **designed** and **engineered** to be used for a maximum height of 400mm (or two UFP's high). We stress that UFPs are not designed or suitable for retaining purposes – they are specifically made to prolong the life of your fence, fill the gap underneath fences and provide extra privacy (gain extra height).

Under Fence Plinth

- 2340 x 200 x 50mm **UFP STD**
- 2340 x 100 x 50mm **UFP CRIB**
- 2355 x 200 x 65-50mm **UFP HD**



Our Products

Step Kits

Step Kits for Retaining Walls.

Our Concrete Step Kits are the perfect way to finish off your retaining wall and improve its functionality with easy access to different levels in your garden. They are produced as a kit and come in size options of 2m and 2.4m width to ensure they will match your landscape project requirements.

We produce our steps kits to match all of our concrete sleepers: Cove, Ashwood, Kensington, McLaren, Blackwood and Lonsdale; allowing you to perfectly finish off your retaining wall with steps that will not only match but have the same level of quality and durability.

One layer is 200mm high, this includes 2 x sides, 2 x treads and a crib (the crib will match the pattern of the sleeper), they are the same height as a sleeper and same colours that the sleepers are available in Grey, Charcoal and Sandstone.

They are available as a kit that starts at 1 step high (200mm high) to 6 steps high (1.2m high).

If you require higher steps you can increase the step height from 1.2m by using another step kit to make the heights you require, this will require extra step treads to continue the step landing.



Step kit includes per layer:

2 x Sides, 2 x Treads, 1 x Crib,
2 x Plates and 4 x Pins.

Side: 2000 x 200mm x 80mm

Tread: 2000 x 200mm x 100mm
2400 x 200mm x 100mm

Crib: 2000 x 100mm x 100mm
2400 x 100mm x 100mm

Please note: Chemical Anchor Not Included.

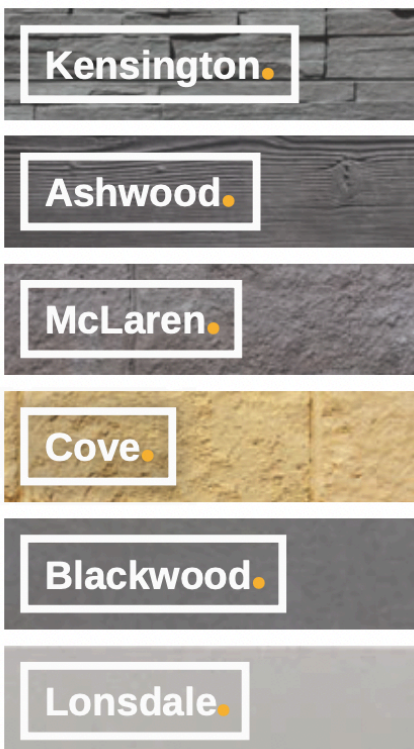

Our Products

Steel + Sleeper Lifter

Steel for Retaining Walls.

Get your retaining wall steel delivered with your sleepers and save time and money. We don't charge extra for delivering your steel. Most importantly, we will ensure that you receive high-quality steel posts and, the correct steel type* required for your retaining wall.

We offer Galvanised steel posts and can supply any size and type of steel required for your project. Generally, this will be for walls that are designed by an engineer, with the size and type of steel required stated on the walls technical specifications. For more information, please contact our Sales team for assistance.

Steel Sizes:

Universal column "H" post available in:

100UC14.8
150UC20.3
150UC30
200UC50

Parallel Flange Channel "C" post available in:

100PFC8.3
150PFC17.7
200PFC22.9

**Hot Dipped
Galvanised.**



Sleeper Lifters for Easy Installation of Sleepers.



Save time and your back by lifting our sleepers safely. Sleeper Lifter can be used with a bobcat, dingo or excavator, allowing the sleepers to be put in place without straining yourself. Suitable for installing sleepers in walls of any height.

Australian Designed and Manufactured. Certified testing number NAS4599. Rated for up to 300kg.

- This mechanical retaining wall Sleeper Lifter comes equipped with a lifting eye, which can be attached to any bobcat, excavator, crane, dingo or backhoe.
- Australian designed, engineered and manufactured with a maximum opening width of 140mm and a safe working load of 300kg.
- Fitted with polyurethane blocks that do not mark the concrete sleepers.

Specifications

- Grip range: 10-140mm
- Workload: 300kg
- Light-weight clamp: 21kg
- Dimensions: 540 x 390 x 180mm
- Manual lock for easy release
- Long lasting polyurethane pads
- Replacement polyurethane pads available
- Certified testing number #NAS4599.

Installation Guide Concrete Sleepers



1. Hole centre.

- Set pegs at each end of the retaining wall site and connect with a string line to give the required alignment.
- Holes should be dug at 2010mm centres for 2.0m sleepers and 2410mm for 2.4m sleepers (Note: a similar allowance of 10mm can be used for other lengths).
- Hole diameter must be at least 450mm.

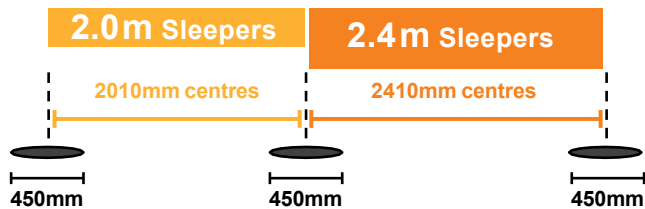

2. Post holes.

- For a one metre wall, the post holes must be dug 1100mm deep.
- After ensuring that the post tops are the same height, place steel in the hole and concrete.

note: DO NOT OVERFILL HOLES.

For all walls over 1m pier depth to be confirmed by a qualified engineer.

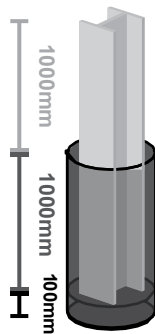

3. String line.

- With the string line still in place, check the alignment of all posts with a spirit level.
- Re-check distances between posts. This can be done with a tape measure or a piece of cord cut at 2010mm or 2410mm.



4. Sleepers.

- Ensure concrete has cured overnight.
- Place first sleeper between posts, then proceed to check the measurement from the top of the sleeper to the top of each post.
- If concrete is not level use fibro-cement sheeting for packaging under the bottom of the sleeper to adjust height, then install the rest of the sleepers.
- Check the measurements from the top of the post to sleeper as you go.

note wedge/packers: If necessary make wedges from scrap timber to ensure sleepers are held against the front of the post until backfill.

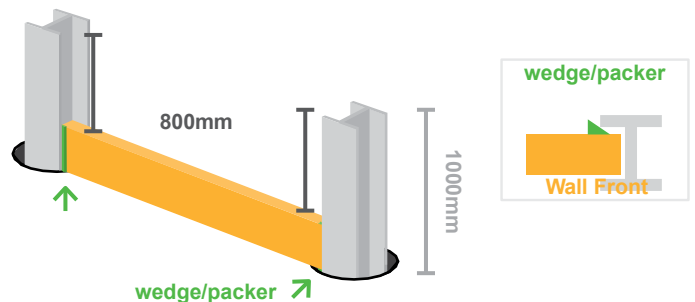

5. Drainage.

- Once sleepers have been installed, place a plastic membrane (Forticon) behind the wall and AG pipe or strip drain at bottom (back) of the wall. (See diagram)
- Drain matting should also be used along the bank
- Cover the pipe with 20mm gravel for drainage.
- Check technical specifications with Engineer.

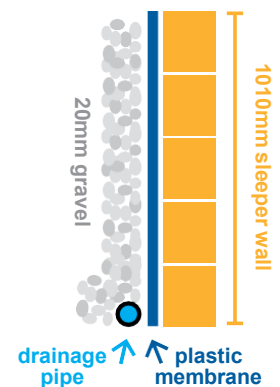

Council approval may be required

- Engineering approval if over 1m
- Less than 1m high
- Check with your local council.

note: Please ensure that during installation no equipment is to be driven over the backfill within 75% of the wall height. Compaction, if any, within this area should be with non-vibrating hand equipment, weighing no more than 500kg per square metre of footprint. If greater compaction is required, please obtain engineering advice. Wall designs shown are for 'typical' soil conditions. For walls over 1 metre, you should seek independent engineering advice based on your specific site conditions.

Installation Guide

Under Fence Plinth



- Retain the life of your fence and fill the gap underneath your 'Panel Fence' or 'Post and Rail Fence' by using an UFP from *Outback Sleepers Australia*.
- Prolong the life of the fence by preventing the steel (or other material) from sitting on the dirt and rusting.
- The UFP's available from *Outback Sleepers Australia* are designed to fit into a 50 x 50mm fence post.

1. Fence Posts.

- Install your fence posts as specified by the Fence panel manufacturer.
note: *Outback Sleepers Australia* recommends that the posts be extended and the hole dug a further 300mm deeper than the fence manufacturer's recommendation.

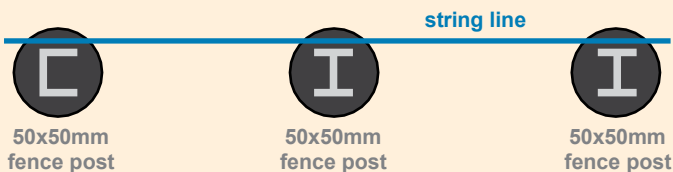

2. Remove Rail.

- Remove bottom fence rail.

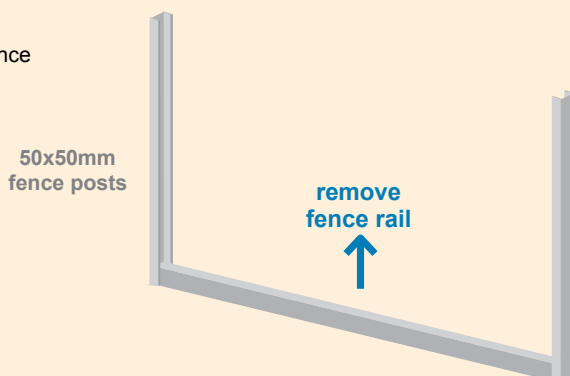

3. Concrete uFP.

- Insert concrete sleeper under fence plinth in between posts.

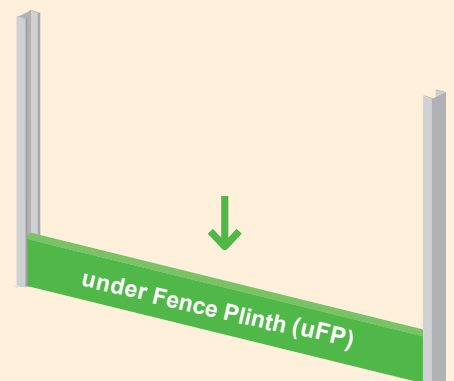

4. Replace Rail.

- Replace bottom rail, as per fence manufacturer's instructions.

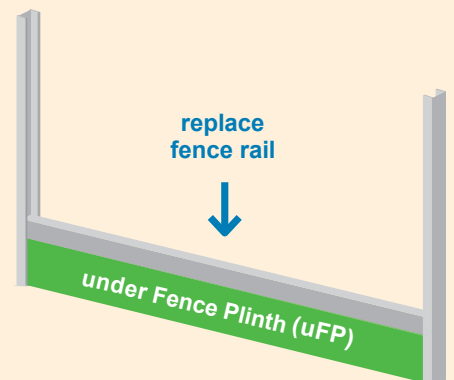

5. Fence Panel.

- Install fence panel, as per fence manufacturer's instructions.

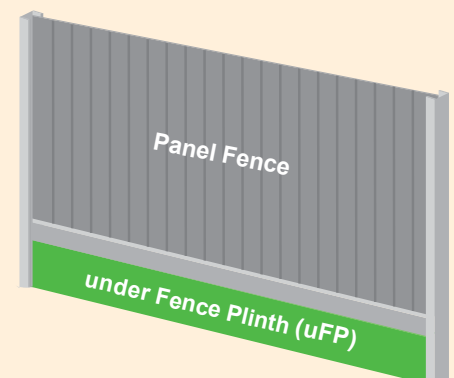

Installation Guide

Step Kits



What you'll need:

- Sleepers (2 x each layer)
- Step Treads (2 x each layer)
- Step Support Plates (2 x each layer)
- Crib / Riser (1 x each layer)
- Locating Pins (4 x each layer)
- Masonry Drill
- 10mm and 12mm Masonry bits
- Chemical Anchor Cartridge.

1. Prepare Side Sleepers.

Line up Side Sleepers (smooth side up) on timber bearers. Place first Step Support Plate 100mm from edge on bottom layer. Use Alignment Markers or measurements (provided) to place subsequent Step Plates.

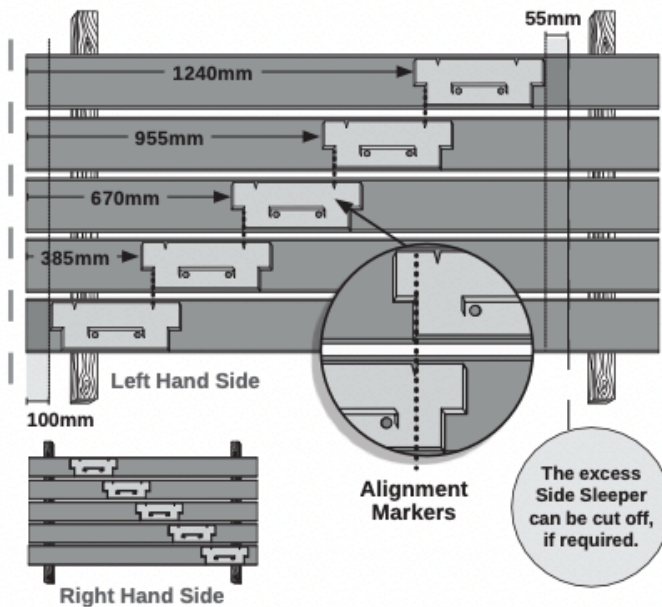

2. Attach Step Plates

Drill holes into Side Sleeper. Tilt and brush or vacuum holes to ensure they are clean. Half fill holes with Chemical Anchor glue, twist Locating Pins all the way into base of holes and attach Step Support Plates.

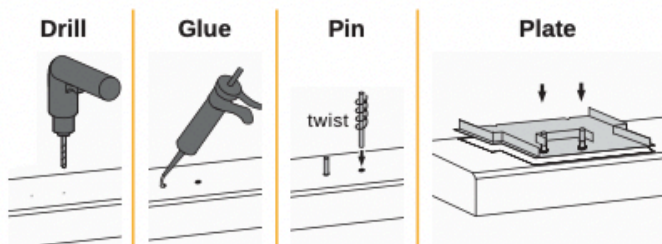

3. Build Steps.

Starting from the bottom, place the lowest Side Sleeper between the Channel Columns, one layer at a time: Side Sleeper, Crib / Riser, Step Tread, repeat until completed.

Side Sleeper

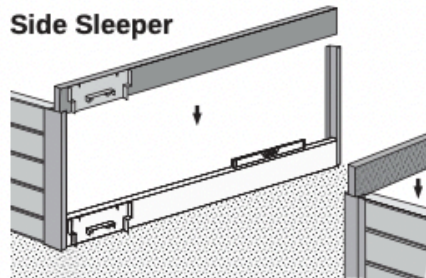

Crib / Riser

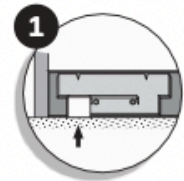
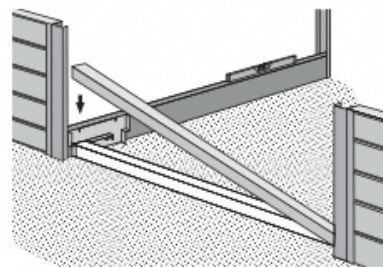

Step Treads

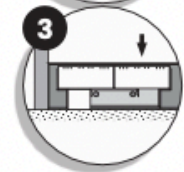
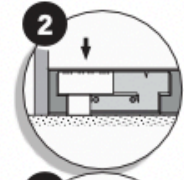
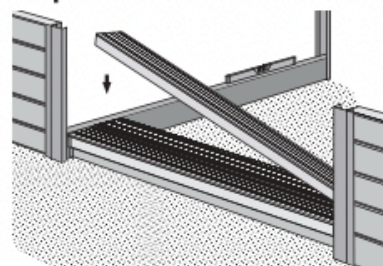

Repeat

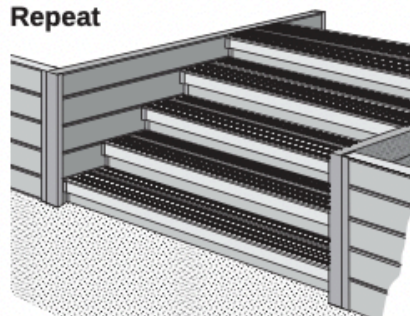

Compatible with the Landing Platform Kit for stairs over 6 steps high.



Further Information.



Delivery and Pick up.

Transport

- Dedicated delivery vehicles.(via sub contractor)
- Forklift (Manitou) for site access.
- Kerbside delivery.
- Large Load capacity for commercial customers.

Loading Area

- Pick up available from Concrete Sleepers N.S.W Ourimbah.
- Our loading areas can accommodate vehicles with trailers up to B-double trucks.

Please note: We do not load cars, vans or cage trailers.

Concrete Sleepers.

Important Information:

Specifications

Sleeper concrete strength is **60MPa**.

no heavy mechanical compaction within 75% height of wall.

These sleeper specifications are only suitable for use with retaining walls which satisfy the following conditions/limitations:

- The wall is not subject to heavy surcharge loads, for example; nearby existing retaining wall; structure; buildings within a distance equal to two times the wall height or placing a fence on the retaining wall.
- The final surface gradient above the wall is level or only slight (i.e less than 1 vertical rise in 10 horizontal).
- The wall backfill is free draining (consisting drainage gravel).
- All sub-surface water is drained by means of an agricultural drain or other suitable method.
- Sleepers minimum end bearing length shall not be less than 25mm each end.

note: Please check with your local authority for specific regulations.

Sleeper engineering specification:

- **60 MPa**
- Concrete complies with AS3600/2018.
- Engineered and Certified.
- 50 Year Design Life-span.



DRAWINGS

1CM=1M

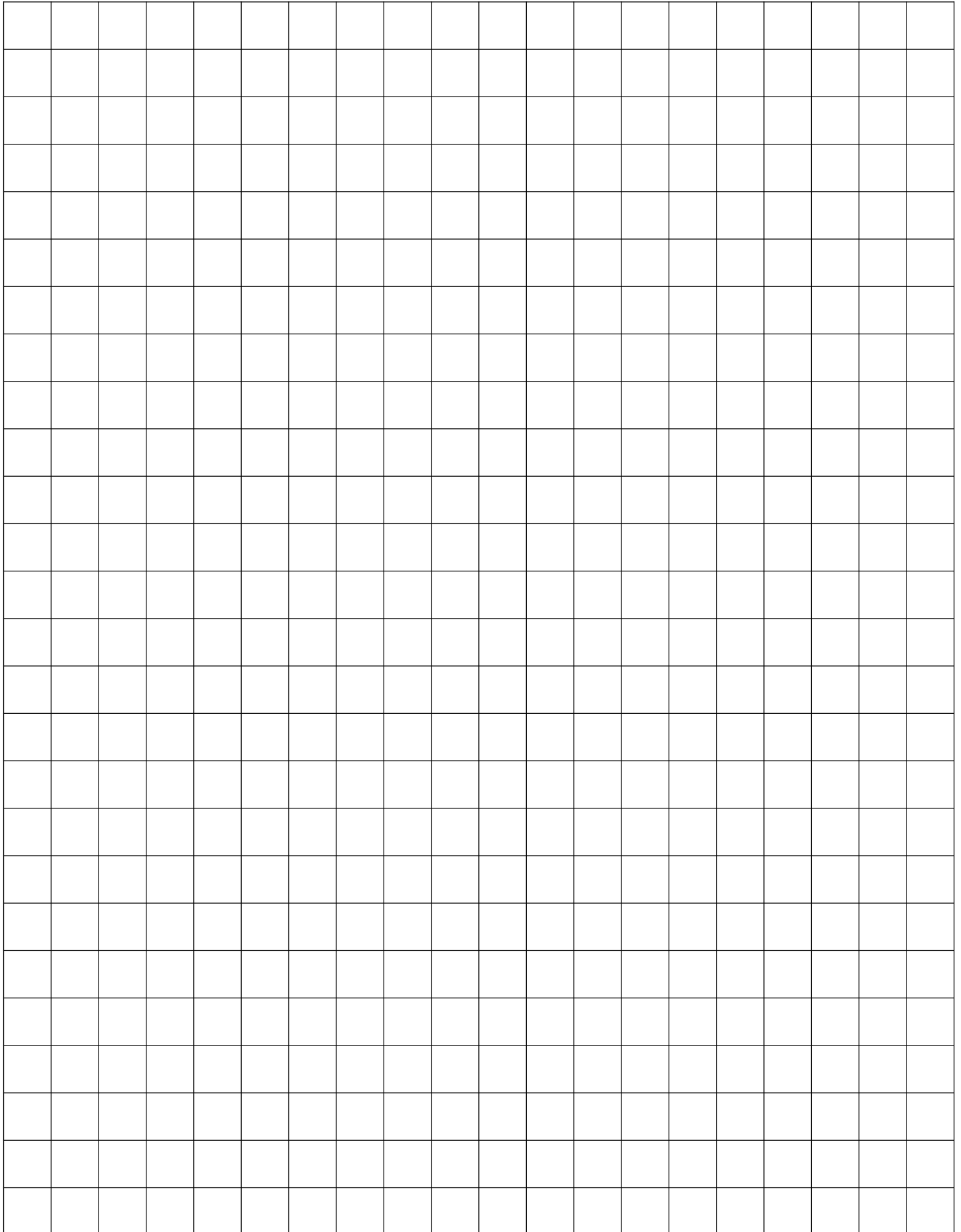

Please include height every 2 meters

ORDER FORM.

SLEEPERS	1.5M (STD)	2M (STD)	2M (HD) (SO)	2M (EHD) (SO)	2.35M (STD) (SO)	2.4M (STD)	2.4M (HD) (SO)	2.4M (EHD) (SO)
LONSDALE								
BLACKWOOD								
COVE								
McLAREN								
KENSINGTON								
ASHWOOD								
POST 100MM	900	1200	1500	1800	2100	2400	2700	3000
C								
H								
90°								
45° (SO)								

POST 150MM (SO)	2400	2700	3000	3300	3600	3900	4200	4500	4800	5100	5400	5700	6000
H													
C													

POST 200MM (SO)						3900	4200	4500	4800	5100	5400	5700	6000
H													
C													

Special order(SO) 1 week turnaround**

Concrete Sleepers N.S.W recommendations:

1. Holes are drilled minimum 450mm in diameter
2. Holes are drilled to a depth 100mm greater than half the post length
3. Post should be installed 50% in the concrete and 50% above ground*
4. Council approval for walls over 600mm in height
5. Engineering for walls over 1000mm in height

*Depending on ground suitability

**Depending on supplier stock

Please note these are recommendations only. Owners and builders should check with their engineer and local council before building a retaining wall structure.

Caring for your Sleepers

Maintenance:

Keep your sleepers looking at their best:

DO follow the installation guides in our Product Guide on how to build your retaining wall.

DO use plastic (Forticon) behind the sleepers before backfilling the wall.

DO use a slotted drain pipe at the base of the wall to allow drainage.

DO NOT scrub the face of the sleepers to remove dirt or stains; Use light pressure from a garden hose to soften the dirt or stain and remove by hand (if possible).

DO NOT use a pressure hose or any chemical solutions to clean the sleepers / UFP's.

DO NOT subject the concrete sleepers / UFP's to excessive water hitting the face from a sprinkler system.

Hairline cracks can be prevalent in all concrete products however, they rarely affect the structural integrity of our concrete sleepers. Please contact our friendly staff if you have any queries regarding hairline cracks in your concrete sleepers.

Lime Bloom / Efflorescence:

What is Lime Bloom & Lime Stain?



All concrete products are susceptible to Lime Bloom which can appear on your concrete sleepers as thin white patches. Lime Bloom is temporary and typically disappears as a result of normal weathering.

People can often mistake Lime Bloom as a defect in the product or poor-quality product colour control, but this is not the case. Lime Bloom is not detrimental in any way to the structural integrity of the concrete sleeper and is purely an aesthetic issue only.

Lime bloom / Efflorescence remover can be purchased from most large hardware stores

Note. Use in a small conspicuous area to confirm desired effect before applying to the entire product.



Contact us •

2 Burns Road,
Ourimbah N.S.W 2258

Sagi: 0457 366 500
Vinny: 0493 059 413

sales@ConcreteSleepersNSW.com.au

www.ConcreteSleepersCentralCoast.com.au

www.ConcreteSleepersNSW.com.au

